



MONARCH

INSTRUMENT

the Professional's Choice

Measurement
Quality Control
Process Inspection
Predictive Maintenance



*Tachometers • Stroboscopes
Speed Sensors • Temperature/Humidity Sensors
Frequency Converters • Vibration Meters • Data Acquisition*



www.monarchinstrument.com

Nova-Pro® Stroboscope/Tachometer



Patented Technology



Nova-Pro® is a series of powerful portable visual inspection and speed measurement tools. We have combined all the features of our handheld LED stroboscopes together with a full function laser tachometer to create a compact, ergonomic and extremely powerful two-in-one predictive maintenance tool. The stroboscope light source comprises twelve LEDs that are extraordinarily bright yet extremely efficient, allowing cool continuous operation and extremely long battery life on a single charge. Continuous operation is also possible with the optional AC adapter.

Nova-Pro 100: designed for simple stroboscopic stop motion inspection and RPM measurement applications. The integral laser module is an optional item that can be added to make the 100 a full-featured non-contact tachometer.

Nova-Pro 300: has all the features of the 100 and adds an additional integral laser module for tachometer mode or strobe trigger mode, a high-contrast inverse blue LCD with backlight and touch-sensitive number pad (for setting flash rates quickly), ultra-high intensity LEDs for even more light output, memory for up to 10 preset flash rates, input and output jacks for external sensors or pulse repeater output, and NIST calibration certificate.

Nova-Pro 500: has all the features of the 300 and adds an additional battery pack, remote laser docking station, phase delay, time delay and virtual slow motion.

Nova-Pro UV365 and UV385 Ultraviolet: has all the features of the 500 and comes in two different ultraviolet LED wavelengths for security print inspection, pharmaceutical process manufacturing, and specular inspection of highly reflective textures and transparent poly-films.

Typical Uses:

- Visually running inspections of fan blades, motors, shafts, gears, rollers, webs, belts, sheaves, chains, sprockets, and much more without having to shut down your process
- Diagnose alignment issues
- Determine the speed of rotating equipment using strobe or built-in laser tachometer
- Troubleshoot high-speed automation processes creating virtual slow motion
- Print quality inspection
- Textile processing inspection
- Phase reference for balancing

Nova-Pro Models

Unique Features	100	300	500	UV365 UV385
Reflective LCD	✓			
White-on-Blue LCD with Backlight		✓	✓	✓
Touchscreen Control		✓	✓	✓
Standard Output LEDs	✓			
High Output LEDs		✓	✓	
UV LEDs				✓
Input/Output Jacks		✓	✓	✓
Tachometer Mode Internal*	✓*	✓	✓	✓
Tachometer Mode External		✓	✓	✓
Programmable Memory		✓	✓	✓
Internal Phase Shifting			✓	✓
Phase Delay			✓	✓
Time Delay			✓	✓
Virtual RPM Mode			✓	✓
NIST Calibration Certificate	*	✓	✓	✓

*Optional on 100

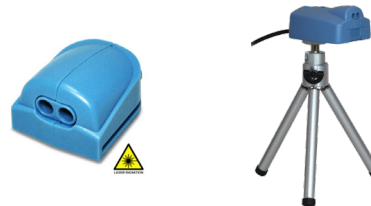

Remote Laser Dock - remove the **Laser Module** from the Nova-Pro and insert it into the Remote Laser Dock with 1/4 x 20 tripod mount. Plug the cable into the external input jack (300 & 500 models) and make measurements in hard-to-reach unsafe areas. (Miniature Tripod sold separately.)



Battery Recharging Station



AC Power Adapter - The 115/230 adapter allows for continuous operation. Included with certain models or may be ordered separately.

Nova-Pro® Stroboscope/Tachometer



Specifications*	100	300	500	UV365	UV385
Flash Range (FPM/RPM)	30 to 999,999				
Display	6-digit numeric and 5-digit alphanumeric LCD reflective	6-digit numeric and 5-digit alphanumeric LCD with touch keypad; high contrast blue background/white characters with backlight			
Accuracy/Resolution	0.001% of setting or ± LSD/6 digits to 0.001				
Light Source	12 LED array	12 high-output LED array		UV 365nm 12 LED Array	UV 385nm 12 LED Array
Flash Duration	Adjustable to 14°/2.000 msec max				
Light Output	3400 lux @ 6000 FPM, 12 inches (30.48 cm), 2° duty cycle, max light output 24,000 lux	5500 Lux @ 6000 FPM, 12 in. (30.48 cm), 2° duty cycle, max light output 30,000 lux		1700 µW/cm2 @ 12", 1% duty cycle	
Color Temperature	Approximately 6200 K			N/A	
External Triggers Input/Output	N/A	TTL (12 V dc max) input; provides 3.3 V dc TTL output			
Tachometer Mode	0-999,999 RPM with integral laser (optional)	0-999,999 RPM with integral laser or external input			
Programmable Memory	N/A	10 setpoints			
Internal Phase Shift		N/A	Yes		
Phase Delay (degrees)		N/A	-360.0 to 345.0		
Time Delay (milliseconds)		N/A	-50.000 to 50.000		
Virtual RPM - Slow Motion		N/A	-60.0 to 60.0		
Operating Time	Battery pack: 9.5 hours typical (6000 FPM, 2° duty cycle)				
Power Supply - Battery	Removable/rechargeable Li-ion battery pack with 100-240 50/60 Hz recharging station		Removable/rechargeable Li-ion battery packs (qty. 2) with 100-240 50/60 Hz recharging station Note: UV stand-alone includes 1 battery pack; kits include 2 battery packs		
Power Supply - AC (optional)	100-240 V ac 50/60 Hz AC adapter with 6-foot [2M] cable and interchangeable wall plugs				
Weight	1.4 lbs. (635 g) with standard battery				
Dimensions (H x W x D)	9.5 x 3.75 x 5.5 in. / 241 x 95 x 140 mm				
Housing Material/Rating	ABS/IP54				

*Specifications are subject to change without notice.

Ordering Information

Model	Description	Part No.
Nova-Pro 100	100 Strobe, standard battery, recharging station with interchangeable wall plugs	6241-010
Nova-Pro 100 Kit	Same as above with latching carry case	6241-011
Nova-Pro 300	300 Strobe, laser module, standard battery, recharging station with interchangeable wall plugs and NIST Certificate	6243-010
Nova-Pro 300 Kit	Same as above with latching carry case	6243-011
Nova-Pro 500	500 Strobe, laser module w/remote laser dock, (2) standard batteries, recharging station w/ interchangeable wall plugs and NIST Certificate	6245-010
Nova-Pro 500 Kit	Same as above with deluxe die-cut foam lined watertight carry case	6245-011
Nova-Pro 100 AC	100 Strobe, 115/230 V ac adapter with interchangeable wall plugs	6241-020
Nova-Pro 100 AC Kit	Same as above with latching carry case	6241-021
Nova-Pro 300 AC	300 Strobe, laser module, 115/230 V ac adapter with interchangeable wall plugs and NIST Certificate	6243-020
Nova-Pro 300 AC Kit	Same as above with latching carry case	6243-021
Nova-Pro UV365	UV365 Strobe, laser module w/ remote laser dock, standard battery, recharging station w/ interchangeable wall plugs and NIST Certificate	6248-010
Nova-Pro UV365 Kit	Same as above with a second battery and deluxe watertight case	6248-011
Nova-Pro UV385	UV385 Strobe, laser module w/ remote laser dock, standard battery, recharging station w/ interchangeable wall plugs and NIST Certificate	6249-010
Nova-Pro UV385 Kit	Same as above with a second battery and deluxe watertight case	6249-011

Accessories available on website

NIST Certification optional for Nova-Pro 100 (see website).

For details, see Nova-Pro webpages.

www.monarchinstrument.com // sales@monarchinstrument.com // 800-999-3390

PLS Pocket LED Stroboscope



7 LED Array



The PLS Pocket LED Stroboscope is a compact, rugged, lightweight device that provides a super bright, uniform light output for performing visual diagnostic inspection and RPM measurements. The silent cool running LEDs are extremely energy efficient, providing up to 6 hours of operation on a single charge. The PLS has a wide operating range of 30-300,000 flashes per minute, which covers most industrial applications. Additional features include external input for remote triggering or tachometer mode, pulse output, memory for up to 5 preset flash rates, NIST calibration certificate, tachometer mode for speed measurements up to 300,000 RPM using optional remote sensors and TTL pulse output.

Features:

- Intuitive one-handed operation
- Energy efficient with long battery life
- Extremely bright, uniform light
- Quiet, cool operation
- Compact size
- No lamp replacements
- Lightweight
- Digital backlit LCD
- Tripod mounting bushing (1/4"-20)
- NIST Certificate included

Specifications*	PLS Pocket LED Strobe	
Display	LCD with 6 numeric 0.506 in. [12.85 mm] high digits and 5 alphanumeric 0.282 in. [7.11 mm] high digits	
	Flash Range	30-300,000 FPM, 0.5 to 5000 Hz
Indicators	Flash Rate Accuracy	0.005% of setting or ± last digit
	Flash Rate Resolution	0.01 to 1 FPM (menu selectable), 0.1 FPM resolution above 9,999.99 FPM, 1 FPM resolution above 99,999.9
Memory	Last setting before power down is remembered and restored on next power-up; 5 user-settable memory locations	
	Flash Duration	Adjustable 0.5 to 2500 µs or 0.1 to 10° of rotation (auto adjusts with flash rate)
Power	Battery-powered; internal Li-ion rechargeable batteries 3.6 V dc	
Light Source	7 LED array	
Light Output	3300 lux at 6000 FPM 12 in. [30.48 cm] from lens 2° duty cycle; max light output: 8300 lux	
Color Temperature	Approximately 6200 K	
Run Time	5-6 hours typical @ 6000 FPM, and 2.0° duty cycle with fully charged batteries	
Charge Time	4-5 hours typical with supplied charger	
Weight	0.6 lbs. (0.27 kg) including batteries	
Dimensions	7.75 x 2.75 x 2.3 in. 197 x 70 x 58 mm	
Internal Mode		
External Modes		
Flash Range	0-300,000 FPM, 0 to 5000 Hz	
Tachometer Mode	30 to 300,000 RPM	
Accuracy	±0.005% of reading or ± last digit	
Display Update Rate	0.5 second typical above 120 RPM	
Trigger to Flash Delay	Approximately 15 µsec	
External Input	2.5 V to 12 V peak pulse 500 ns min pulse width, positive or negative edge triggered (menu selectable)	
Pulse In to Out Delay	< 0.2 µsec	
Output Pulse	3V pulse; one pulse per flash in internal mode - mimics input pulse in external mode	

*Specifications are subject to change without notice.

Accessories:

Remote Optical Laser Sensor
PN 6180-029



Remote Optical LED Sensor
PN 6180-057



Replacement Lithium Battery
Charger 115/230 with
interchangeable plugs
PN 6280-027



Reflective Tape - 5-ft. x 1/2" roll
PN 6180-070

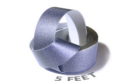

Protective Carry Pouch
PN 6280-073



Replacement Li-ion Battery Pack
PN 6280-047



Miniature Tripod
PN 6280-049



Ordering Information

Model	Description	Part No.
PLS	Pocket LED Stroboscope, universal 115/230 V ac recharger with interchangeable wall plugs and NIST Certificate	6235-010
PLS Kit	Same as above with die cut foam lined latching carry case	6235-011
PLS Kit Plus	Same as PLS Kit above. Also includes ROLS-P Remote Optical Laser Sensor for triggering flash or for use as a laser tachometer	6235-012

[Accessories available on website](#)

[For details, see PLS webpage.](#)

Nova-Strobe™ LED Stroboscopes

The Nova-Strobe™ LED family of rugged industrial stroboscopes provides an extremely bright, uniform light output for performing stop motion diagnostic inspection and RPM measurements. The twelve LED light source is extremely efficient, which means long battery life and continuous cool operation. A wide operating range of 30-500,000 flashes per minute covers all applications. The Basic BBL is designed for simple stop motion inspection and RPM measurement applications. The Deluxe DBL adds internal phase shifting, memory for up to 5 preset flash rates, NIST calibration certificate and tachometer mode for speed measurements up to 500,000 RPM using optional remote sensors or TTL pulse input/output. The top of the line Phaser PBL has all the features of the DBL and adds external phase delay, time delay and virtual RPM mode. The PBL will also run continuously 24/7 with the power supply/recharger. Each unit is available stand-alone or as a kit.



Specifications*	BBL Basic	DBL Deluxe	PBL Phaser
Flash Range (FPM/RPM)	30-500,000		
Display	6-digit numeric and 5-digit alphanumeric LCD		
Accuracy/Resolution	0.01%...	0.004% of setting or ± least significant digit/0.01 FPM	
Light Output	4200 lux @ 6000 FPM, 12 inches [30.48 cm], 2.0° duty cycle Max light output: 27,000 lux		
Flash Duration	Adjustable to 14°/3000 µsec max		
Light Source	12 LED array		
Color Temperature	Approximately 6200 K		
External Triggers (in/out)	N/A	TTL (24 V dc max) input; provides 5.0 V dc TTL output	
Tachometer Mode	N/A	0-500,000 RPM (use with optional remote sensor)	
Programmable Memory	N/A	Yes	
Internal Phase Shift	N/A	Yes	
Phase Delay (degrees)	N/A		0.1 to 359.9
Time Delay (milliseconds)	N/A		0.01 to 1000
Virtual RPM - Slow Motion	N/A		0-200 VRPM
Operating Time	8-10 hours typical @ 1800 FPM		8-10 hours typical @ 1800 FPM with batteries or continuous-use power supply
Power Supply	Internal NiMH rechargeable batteries with 115/230 50/60 Hz recharger		Internal NiMH rechargeable batteries or continuous-use 115/230 50/60 Hz V ac power supply/recharger
Weight	1.9 lbs. (860 g)		
Dimensions (L x W x H)	Body: 9 x 3.66 x 3.56 in. [229 x 93 x 90 mm]; Reflector housing: 4.8 in. [122 mm] dia.; Handle: 4.254 in. [108 mm] long		

*Specifications are subject to change without notice.

Ordering Information

Model	Description	Part No.
Nova-Strobe BBL	BBL Strobe, universal 115/230 recharger with interchangeable wall plugs	6230-010
Nova-Strobe BBL Kit	Same as above with standard latching carry case	6230-011
Nova-Strobe DBL	DBL Strobe, universal 115/230 recharger with interchangeable wall plugs and NIST Certificate	6231-010
Nova-Strobe DBL Kit	Same as above with standard latching carry case	6231-011
Nova-Strobe PBL	PBL Strobe, universal 115/230 power supply/recharger with interchangeable wall plugs and NIST Certificate	6232-010
Nova-Strobe PBL Kit	Same as above with deluxe watertight carry case	6232-011

Features:

- Bright, uniform light pattern
- Lightweight industrial design
- Digital backlit LCD (DBL, PBL)
- Tripod mounting bushing (¼"-20) in handle
- NIST Certificate included with DBL and PBL
- 12 button keypad makes entering flash rates extremely quick (DBL, PBL models)
- Continuous 24/7 operation (PBL)

Accessories:

Remote Optical Laser Sensor
PN 6180-029



Splashproof Cover
PN 6280-041



Protective Rubber Cover
PN 6280-048



Reflective Tape - 5-ft. x 1/2" roll
PN 6180-070



Pulse Input/Output Cable (BNC)
PN 6280-037



Standard Latching Carry Case
PN 6280-040



Deluxe Watertight Carry Case
PN 6280-049



Accessories available on website

NIST Certification optional for BBL (see website).

For details, see Nova-Strobe LED webpage.

Nova-Strobe™ Xenon Stroboscopes



Nova-Strobe™ xenon models are the standard for high-intensity multi-function portable stroboscopes. Models are available with internal rechargeable battery or AC power, and a useful range of features that provide unmatched performance and value. Four models range from the Nova-Strobe BAX Basic, the most cost-effective AC-powered digital strobe, up to the Nova-Strobe DBX Deluxe, the most versatile battery-powered digital strobe with internal phase shifting.

Both the battery-powered Nova-Strobe DBX and AC-powered Nova-Strobe DAX provide a range of 30 to 20,000 flashes per minute and an accuracy of ± 0.004% of setting. Flash rates are easily adjusted to fractional RPM by a coarse/fine control knob. Individual TTL compatible input and output jacks are provided for daisy-chaining multiple strobes, triggering from an external source, or providing a trigger signal to external equipment.

Both DBX and DAX models provide internal phase shifting to keep the target precisely in view. In addition, nine user-programmable memory flash rates for repetitive measurements and storage of the last flash rate measured are included. All models provide x2/÷2 capability for distinguishing actual RPM from harmonic frequencies.



Features:

- Internal rechargeable batteries or AC powered models
- Lightweight (less than 2.0 pounds) for easy handling
- Continuous cool operation
- Tripod mountable

Nova-Strobe DBX & DAX add:

- NIST Traceable Calibration Certificate
- Internal phase shifting for easy reference target viewing
- Tach mode, speed measurement up to 250,000 RPM
- Power for optional sensors
- Pulse repeater output



Specifications*	BBX Basic Battery	BAX Basic AC	DBX Deluxe Battery	DAX Deluxe AC
Range Flashes/Minute	30-10,000 FPM		30-20,000 FPM	
Display	6-digit numeric and 5-digit alphanumeric LCD			
Accuracy/Resolution	±1 FPM/1 FPM		0.004% of setting or ± last digit/ 0.01-1 FPM	
Flash Energy/Duration	230 mJoule up to 3450 FPM / 8-20 µsec			
Average Power (Watts)	> 13W above 4000 FPM			
Flash Tube & Life	Higher power xenon, 100 million flashes typical			
External Triggers - in/out (1/8" [3.5 mm] phone jack)	N/A		Input: TTL (24 V dc max) Output: provides 3.3 V dc TTL	
Tachometer Mode	N/A		5-250,000 RPM (use with optical remote sensor)	
Programmable Memory	N/A		Yes	Yes
Internal Phase Shift	N/A		Yes	Yes
Operating Time	2 hours typical @ 1800 FPM	Continuous	2 hours typical @ 1800 FPM	Continuous
Power Supply	Internal NiMH rechargeable batteries	115 V ac, 50-400 Hz or 230 V ac, 50-400 Hz	Internal NiMH rechargeable batteries	115 V ac, 50-400 Hz or 230 V ac, 50-400 Hz
Weight	1.9 lbs. (0.86 kg)	1.5 lbs. (0.68 kg)	1.9 lbs. (0.86 kg)	1.5 lbs. (0.68 kg)
Dimensions (L x W x H)	Body: 9 x 3.66 x 3.56 in. [229 x 93 x 90 mm]; Reflector housing: 4.8 in. [122 mm] dia.; Handle: 4.25 in. [108 mm] long			

*Specifications are subject to change without notice.

Ordering Information

Model	Description	Part No.
BAX 115	Basic 115 V ac powered xenon Strobe	6206-010
BAX 115 Kit	Same as BAX 115 plus latching carry case and spare lamp	6206-011
BAX 230	Basic 230 V ac powered xenon Strobe	6206-012
BAX 230 Kit	Same as BAX 230 plus latching carry case and spare lamp	6206-013
BBX 115/230	Basic xenon Strobe, battery powered, with 115/230 V ac recharger with interchangeable plugs	6207-012
BBX 115/230 Kit	Same as BBX 115/230 plus latching carry case and spare lamp	6207-013
DAX 115	Deluxe 115 V ac powered Strobe with NIST Certificate	6203-010
DAX 115 Kit	Same as DAX 115 plus latching carry case and spare lamp	6203-011
DAX 230	Deluxe 230 V ac powered Strobe with NIST Certificate	6203-012
DAX 230 Kit	Same as DAX 230 plus latching carry case and spare lamp	6203-013
DBX 115/230	Deluxe Strobe, battery powered, with 115/230 V ac recharger with interchangeable plugs and NIST Certificate	6204-012
DBX 115/230 Kit	Same as DBX 115/230 plus latching carry case and spare lamp	6204-013

Accessories available on website

NIST Certification optional for BAX and BBX (see webpages).

For details, see Nova-Strobe Xenon webpage.

PBX Phaser Stroboscope

The Phaser-Strobe PBX incorporates the unique design features of the Nova-Strobe DBX with an increased operating range of 30 to 50,000 flashes per minute, as well as external phase shifting. The unique digital adjustment knob can select the decade for adjustments so coarse and fine adjustments of flash rates are made quickly and with significantly better resolution than competitive units. The memory feature of the Phaser-Strobe PBX allows nine flash rates to be stored - displayed in flashes per minute or flashes per second. Phaser-Strobe PBX operates with internal rechargeable batteries or continuously from AC line power with the included power supply/recharger.



Features:

- Phase Shift adjustable as phase angle or time
- Virtual RPM mode provides slow motion viewing for high-speed events
- Store and recall nine memory settings
- TTL compatible input/output jacks
- NIST Traceable Certificate included

Ordering Information

Model	Description	Part No.
PBX 115/230	Strobe with PSC-pbxU 115/230 power supply/recharger and NIST Certificate	6210-020
PBX 115/230 Kit	Same as above with deluxe watertight carry case	6210-021

Accessories available on website

For details, see PBX webpage.

VBX Vibration Stroboscope

The VBX Vibration Strobe is uniquely designed to provide precise, instantaneous synchronization to a number of data collectors and FFT analyzers triggered by an accelerometer. Built for portable applications, the VBX is the perfect lightweight phase analysis tool. VBX allows for the measurement of phase without stopping the machinery to install reflective tape. Phase analysis is quick and accurate using the filter bandwidth selector and the relative phase adjustment. Unique Tracking Filter maintains phase lock to input pulse. VBX can power and be triggered by accelerometers with or without data collectors.



Features:

- Compatible with CSI and SKF analyzers
- Tracking filter maintains phase lock
- Direct triggering from accelerometers
- NIST Traceable Certificate included

Ordering Information

Ordering information for the VBX can be found on the product [webpage](#) or contact Monarch directly for complete part number and pricing details.

Specifications*	PBX Phaser Stroboscope	VBX Vibration Stroboscope
Flash Range	30-50,000 FPM, 0.5-830 FPS (Hz)	
Accuracy	± 0.004% of setting ± least significant digit	
Digital Adjustment Knob	36 detents per revolution and blinking decade selection	
Flash Rate Resolution	0.01 to 1.0 FPM (menu selectable)	
Operating Time	2 hours typical @ 1800 FPM or continuous AC Power	
Phase Delay	0.1 to 359.9°	
Tracking Filter	N/A	Selectable wide and narrow bandwidths; filter may not lock below 100 FPM
Time Delay	0.01 to 1000 msec	
Virtual RPM - Slow Motion	0-200 VRPM	
Flash Energy (typical)	230 mJoule up to 3450 FPM	
Flash Duration (typical)	10-25 µsec (auto adjust)	
Average Power	11W @ 3000 FPM; > 13 W @ 3450 FPM	
Tachometer Mode	5-250,000 RPM from external trigger	
External Input	Input pulse - 0.5 µsec min, TTL to 24 V max (1/8" phone plug)	
Trigger Output/Remote Sync	3.3 V TTL compatible 40 µsec pulse positive/negative	
Power	Internal rechargeable NiMH batteries with AC power supply/recharger	
Weight	1.9 lbs. (0.85 kg) including batteries	

*Specifications are subject to change without notice.



The illumiNova Fixed Mount LED Stroboscopic Inspection Systems are designed for continuous use in high-speed applications requiring crisp, clear, stop motion quality inspection. The extraordinarily bright LEDs provide an ultra uniform white spectrum light. Available in a six-inch model or one-foot lengths up to 8 feet, with three different lens options to ensure you will have light coverage for any job. The powerful onboard intuitive digital controller allows the user to quickly set flash rates, flash duration, brightness levels and many other advanced features. Flash rates can also be triggered remotely using machine-mounted sensors connected directly to illumiNova's digital input or use the optional Remote Controller to extend the operating distance up to 100 feet. Monarch Instrument has been manufacturing the world's most popular portable stroboscopes for over 30 years. We know a thing or two about stop motion analysis. Let us customize an illumiNova Fixed Mount Stroboscopic System to meet your application-specific requirements.



Monarch specializes in unique stroboscopic inspection applications:

- Printing
- Labels
- Converting
- Metal processing
- Paper processing
- Machine vision lighting/synchronization
- Laminated film inspections
- Metalized coatings and finishing
- Fluorescent tags and security printing
- Textiles and non-woven manufacturing
- Pharmaceutical process manufacturing
- Life science research
- High-speed material handling
- Non-contact speed and motion analysis
- High-speed visualization systems
- PET and Polypropylene container inspection



Brightness

The illumiNova gets its brilliance from the delicate balance of forward current or 'full-on' power to the chip and the ratio of duty-cycle/peak-current capabilities of the premium LEDs we use. When combined with user visually-tuned preferences of sharpness and illumination settings, you will have optimal control for creating that perfect slow-motion or freeze-frame effect for your inspection.

Full brightness is not always best with highly reflective and transparent materials or multi-strobe, cross-lighting applications, so we have provided three brightness levels at the twist of a knob. This simple adjustment is also useful to compensate for high ambient lighting conditions and to improve visual acuity in high-contrast environments. In some applications, the ability to synchronize multiple strobes yet independently control their light output makes the illumiNova perfect for these situations.

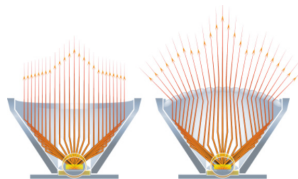

Spot, Flood and Wide Lens Engineered Lighting and Lens Options

Monarch Instrument uses high-intensity white LEDs in clusters of three and pairs them with your choice of three lenses to achieve the optimal illumination area for your application. We use optical-grade polycarbonate acrylic materials to collimate the hundreds of light angles into a controlled illuminating beam perfect for your target area. For the tightest beam focus, use Spot lenses, and for smoother diffused lighting that covers a wider illumination area, use our Flood or Wide directional lenses. UV units are fixed and have no lens options.

Our LED light clusters have been placed in the optimum position to provide an extremely uniform swath of light, free from hot spots or drop-offs, whether you choose a Spot, Flood, or Wide lens options. Every array is designed and engineered for long-term reliability in demanding industrial environments.

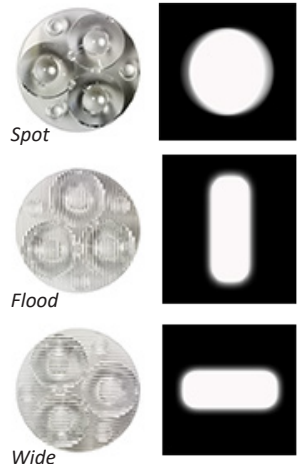

illumiNova Ultraviolet Fixed Mount Strobes

illumiNova Fixed Mount Strobes are also available with ultraviolet LEDs to illuminate UV security markings and UV coatings.

These stroboscopic inspection systems are available with 365nm or 385nm wavelength LEDs. They are optimized for inspection of UV inks on labels, security tags, anti-counterfeiting marks, UV coatings and more.

illumiNova® Fixed Mount LED Stroboscopes

Advanced Features:

• Digital Input/Output

illumiNova includes digital input and output jacks. Have a machine that provides a synchronizing pulse? Simply connect your signal to the input jack of the illumiNova, and the flash will be synchronized with your equipment. If you need to cover a large or irregular area with light, multiple illumiNovas can be connected in series.

• Phase/Time Delay

Use the phase or time delay features to adjust or “position” the virtually stopped image to suit your needs.

• Memory

illumiNova has ten memory presets, allowing you to change from one process speed to the next quickly.

• Adjustable Intensity Levels

Three adjustable light intensity levels give you complete control over the amount of illumination on your process. Low light settings can be used for highly reflective surfaces, while high light settings may be used for darker or high contrast materials.



Intuitive Control

Based on our incredibly popular Nova-Pro series of portable inspection stroboscopes, illumiNova’s onboard controller makes set up and use simple and intuitive. The easy to read inverse LCD is viewable even in high ambient light areas. Flash rates can be quickly entered using the rotary knob or the touch screen keypad.

The optional Remote Controller allows you to be up to 100 feet away in a safe location while an overhead or mid-stream strobe is working in position. The same autonomous Remote Controller can be used on any illumiNova throughout your production facility.



Remote Controller

Application-Driven Design

Designed for the applications we serve, from rotogravure, narrow web and labels, and textiles, to metal finishing inspections, the illumiNova models have a 4.4" x 4.4" square enclosure and range from 9.5 inches [24 cm] to eight feet [254 cm] in length. All illumiNovas can be remotely triggered via machine-mounted sensors or encoders.

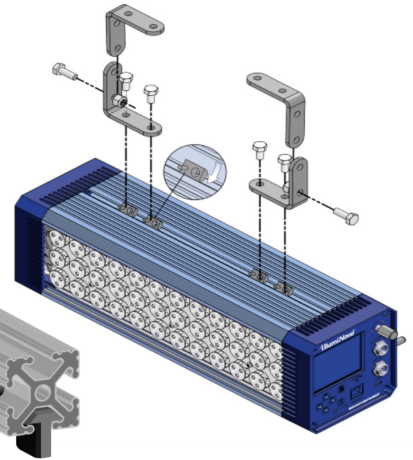

Flexible Mounting Options (80-20® compatible)

The illumiNova housing has an integral 80-20® compatible T-slot framing system built into three sides of its frame. Use the included mounting brackets or select from a wide range of 80/20® industrial mounting hardware readily available. This is practical for our narrow width models by setting up quick-mount utility frames allowing them to perform double-duty at multiple inspection points along the production line.

Monarch offers 9 models of the illumiNova ranging in size from 6" to 96", each with 3 different lens options.



1 FOOT in WIDTH

illumiNova 100 - 1 ft. wide



2 FEET in WIDTH

illumiNova 200 - 2 ft. wide



3 FEET in WIDTH

illumiNova 300 - 3 ft. wide



4 FEET in WIDTH

illumiNova 400 - 4 ft. wide



6 INCHES in WIDTH

illumiNova 50 - 6 in. wide



5 FEET in WIDTH

illumiNova 500 - 5 ft. wide



6 FEET in WIDTH

illumiNova 600 - 6 ft. wide



7 FEET in WIDTH

illumiNova 700 - 7 ft. wide



8 FEET in WIDTH

illumiNova 800 - 8 ft. wide



illumiNova Lux and Illumination Specifications:

Spot



		Distance to target	
		Pulse Width 3.6/100 usec @ 6K High Setting	
Model	Lux	Width x Height (inches)	Width x Height (cm)
Effective Illumination Area			
50	3700	14 x 14	36 x 36
100	7250	18 x 14	46 x 36
200	8150	30 x 14	76 x 36
300	8430	42 x 14	107 x 36
400	8500	54 x 14	137 x 36
500	8570	66 x 14	168 x 36
600	8600	78 x 14	198 x 36
700	8660	90 x 14	229 x 36
800	8660	102 x 14	259 x 36

		Distance to target	
		Pulse Width 3.6/100 usec @ 6K High Setting	
Model	Lux	Width x Height (inches)	Width x Height (cm)
Effective Illumination Area			
50	1000	24 x 28	61 x 71
100	2290	30 x 28	76 x 71
200	3760	42 x 28	107 x 71
300	4190	54 x 28	137 x 71
400	4350	66 x 28	168 x 71
500	4430	78 x 28	198 x 71
600	4450	90 x 28	229 x 71
700	4520	102 x 28	259 x 71
800	4500	114 x 28	290 x 71

Flood



		Distance to target	
		Pulse Width 3.6/100 usec @ 6K High Setting	
Model	Lux	Width x Height (inches)	Width x Height (cm)
Effective Illumination Area			
50	1465	11 x 36	28 x 91
100	2865	20 x 36	51 x 91
200	3480	32 x 36	81 x 91
300	3735	44 x 36	112 x 91
400	3810	56 x 36	142 x 91
500	3925	68 x 36	173 x 91
600	3960	80 x 36	203 x 91
700	3980	92 x 36	234 x 91
800	4000	104 x 36	264 x 91

		Distance to target	
		Pulse Width 3.6/100 usec @ 6K High Setting	
Model	Lux	Width x Height (inches)	Width x Height (cm)
Effective Illumination Area			
50	389	13 x 72	33 x 183
100	858	18 x 72	46 x 183
200	1360	30 x 72	76 x 183
300	1675	42 x 72	107 x 183
400	1745	54 x 72	137 x 183
500	1805	66 x 72	168 x 183
600	1850	78 x 72	198 x 183
700	1910	90 x 72	229 x 183
800	1895	102 x 72	259 x 183

Wide



		Distance to target	
		Pulse Width 3.6/100 usec @ 6K High Setting	
Model	Lux	Width x Height (inches)	Width x Height (cm)
Effective Illumination Area			
50	1627	36 x 18	91 x 46
100	3100	42 x 18	107 x 46
200	5690	54 x 18	137 x 46
300	6890	66 x 18	168 x 46
400	7380	78 x 18	198 x 46
500	7550	90 x 18	229 x 46
600	7640	102 x 18	259 x 46
700	7690	114 x 18	290 x 46
800	7690	126 x 18	320 x 46

		Distance to target	
		Pulse Width 3.6/100 usec @ 6K High Setting	
Model	Lux	Width x Height (inches)	Width x Height (cm)
Effective Illumination Area			
50	427	72 x 32	183 x 81
100	800	78 x 32	198 x 81
200	1587	90 x 32	229 x 81
300	2240	102 x 32	256 x 81
400	2810	114 x 32	290 x 81
500	3210	126 x 32	320 x 81
600	3500	138 x 32	351 x 81
700	3695	150 x 32	381 x 81
800	3790	160 x 32	406 x 81

illumiNova® Fixed Mount LED Stroboscopes



Specifications*	50	100	200	300	400	500	600	700	800
Controller/Display	6-digit numeric and 5-digit alphanumeric LCD with touch keypad and rotary tuning knob high-contrast blue background with backlight								
Flash Rate	30 to 999,999 FPM								
Accuracy	0.001% of setting or +/- 1 least significant digit								
Resolution	6 digits to 0.001								
Flash Duration (degrees)	0.1-3.5°		0.1 to 4.0°; adjustable in 1-150 µSecs						
LED Array Size (inch/cm)	6 15.24	12 30.48	24 60.96	36 91.44	48 121.92	60 152.40	72 182.88	84 213.36	96 243.84
Number of LEDs	54	108	216	324	432	540	648	756	864
Lux Output @ 6000 FPM/Spot Lens									
@100cm (39.37")	3700	7250	8150	8430	8500	8570	8600	8660	8600
@200cm (78.74")	1000	2290	3760	4190	4350	4430	4450	4500	4500
Available Lens Types	Spot: provides narrowest, brightest illumination area Flood: produces a vertically wide light output to illuminate a larger linear process area Wide: produces a horizontally wide light output allowing smaller strobes to illuminate wider processes								
External Trigger Input	Open collector, dry contract input for sensors (3-5 V dc pulse) provides 5 V dc sensor power isolated input 5-12 V dc 50 mA max								
Prescaler Input	Adjustable from 1-5000 pulses per revolution								
Digital Output	Provides 3.3 V dc TTL output								
Programmable Memory	10 setpoints								
Phase Delay/Time Delay	-360° to +360°/± 50 msecs								
Input Power	115/230 V ac, ± 10%, 50/60 Hz								
VA	37	60	110	160	260	325	360	430	470
Dimensions									
Height	4.374 in./11.11 cm								
Width	4.375 in./11.12 cm								
Length (inch/cm)	9.43 23.97	15.44 39.21	27.43 69.69	39.93 101.44	51.93 131.92	63.96 162.38	75.93 192.88	87.93 223.34	99.93 253.84
Weight (lbs./kg)	4.78 21.68	7.42 3.37	13.26 6.02	19.18 8.70	25.02 11.35	30.10 13.65	36.69 16.64	42.53 19.29	48.36 21.94
Housing Material	Extruded and die-cast aluminum, powder coated								
Housing Rating	IP20								

* Specifications are subject to change without notice.

Ordering Information

Model	Description	Model # + Lens Style + Programming Option = Order #
illumiNova 50	6" LED stroboscope with 54 LEDs 115 or 230 V ac power 50/60 Hz	<div style="display: flex; justify-content: space-around;"> <div style="text-align: center;"> <p>Lens Style:</p> <p>Spot Lens = 1</p> <p>Flood Lens = 2</p> <p>Wide Lens = 3</p> </div> <div style="text-align: center;"> <p>Programming Option:</p> <p>USB = 1</p> <p>Bluetooth = 2 (coming soon)</p> </div> </div> <div style="text-align: center; margin-top: 20px;"> <p>+</p> <div style="border: 1px solid black; width: 30px; height: 30px; display: inline-block; margin: 0 10px;"></div> <p>+</p> <div style="border: 1px solid black; width: 30px; height: 30px; display: inline-block; margin: 0 10px;"></div> <p>=</p> </div> <p style="color: blue; text-decoration: underline;">Accessories available on website</p>
illumiNova 100	12" LED stroboscope with 108 LEDs, 115 or 230 V ac Power 50/60 Hz	
illumiNova 200	24" LED stroboscope with 108 LEDs, 115 or 230 V ac Power 50/60 Hz	
illumiNova 300	36" LED stroboscope with 108 LEDs, 115 or 230 V ac Power 50/60 Hz	
illumiNova 400	48" LED stroboscope with 108 LEDs, 115 or 230 V ac Power 50/60 Hz	
illumiNova 500	60" LED stroboscope with 108 LEDs, 115 or 230 V ac Power 50/60 Hz	
illumiNova 600	72" LED stroboscope with 108 LEDs, 115 or 230 V ac Power 50/60 Hz	
illumiNova 700	84" LED stroboscope with 108 LEDs, 115 or 230 V ac Power 50/60 Hz	
illumiNova 800	96" LED stroboscope with 108 LEDs, 115 or 230 V ac Power 50/60 Hz	
illumiNova UV365	Available in all lengths (as above); contact factory for details	
illumiNova UV385	Available in all lengths (as above); contact factory for details	

Note: All models include onboard intelligent controller, mounting hardware, and NIST Certificate.

For details, see [illumiNova webpage](#).

Palm Strobe x Stroboscope



The Palm Strobe x offers excellent brightness, exceptional features, rugged construction and extra long battery life. Unique one-touch joystick-type button allows single-hand operation for fast fractional RPM tuning. Select mode of operation for internal tuning, external TTL pulse input, tachometer display and x2/÷2 functions. Eight memory positions provide rapid recall of user-defined frequencies. The Palm Strobe x can be ordered in various configurations to fit the demand of your application.

Specifications*	Palm Strobe x
Internal Mode Range	100 to 12,500 FPM (Flashes per minute)
Light Power	7.9 watts @ 6000 FPM, 150 mJoules up to 3100 FPM
Flash Lamp Life	100 million flashes typical
Flash Duration	10 - 30 µsec typical
Display	6 digit alphanumeric backlit LCD
Flash Rate Resolution	0.1 FPM
Flash Rate Accuracy	Greater of ± 0.01% of reading or ± 0.5 FPM
Tachometer Mode	5 to 250,000 RPM
External Input	0 to 5 V dc (12 V dc max) TTL compatible, positive edge triggered
Output Pulse	0 to 5 V dc typical - 350 µsec positive pulse (2.5 mm) 1/8" phone plug
Run Time	2 hours typical @1800 FPM > 1 hour typical @ 6000 FPM
Memory	8 programmable flash rates and last flash rate at power down
Adjustment	Four-quadrant tuner button with blinking decade select for flash rate up and down, multiply by 2 and divide by 2
Modes	Internal, External, Tachometer, Preset, x or ÷ by 2, locked on
Battery Power	Removable 6 V dc rechargeable NiMH battery pack
Recharger	100-240 V ac, 50/60 Hz, includes 4 interchangeable adapters
Weight	1.2 lbs. (0.55 kg) including battery
Dimensions	3.04 x 9.34 in. / 77 x 237 mm

*Specifications are subject to change without notice.



Features:

- Patented plug-in-battery pack
- Easy one-handed operation
- Lightweight
- Flash rates to 12,500 FPM
- Tachometer mode from Self-Powered Sensors
- TTL compatible input/output (3.5mm phone plug)
- NIST Certificate included

Accessories:

Protective Cover
PN 6280-044



Palm Strobe Holster
PN 6280-043



Miniature Tripod
PN 6180-040



Rechargeable NiMH Battery Pack
(in blue/grey housing)
PN 6280-026



L-1905 Replacement Xenon Lamp
PN 6280-028



PSC-2U Universal Recharger
PN 6280-022



Ordering Information

Model	Description	Part No.
Palm Strobe x	Strobe with battery pack, PSC-2U 115/230 V ac recharger and NIST Certificate	6205-050
Palm Strobe x Pak	Strobe with 2 battery packs, PSC-2U 115/230 V ac recharger, holster, and NIST Certificate	6205-051
Palm Strobe x Kit	Strobe, battery pack, PSC-2U 115/230 V ac recharger, spare lamp, and NIST Certificate with a standard carrying case	6205-052
Palm Strobe x Deluxe Kit	Strobe, 2 battery packs, PSC-2U 115/230 V ac recharger, spare lamp, and NIST Certificate with a standard carrying case	6205-053

[Accessories available on website](#)

[For details, see Palm Strobe webpage.](#)



Palm Strobe x Deluxe Kit



Holster for the Palm Strobe x

Pocket Laser Tach 200 (PLT200 Tachometer)

The Pocket Laser Tach 200 (PLT200) is a digital, battery-powered portable optical tachometer, which operates up to 25 feet (8 meters) from a reflective target using a Class 2 laser light source. The ergonomic design allows safe, direct line-of-sight viewing of both the target and the display at the same time, while providing a non-slip rubber surface for single-handed operation.

Multifunction Tool

The PLT200 is a 32-function Tachometer/Rate Meter, Totalizer/Counter and Timer (stopwatch), programmable in both Imperial and Metric units. It includes two phone plug connectors, including an input for our optional Remote Contact Assembly (RCA) or remote sensors and a TTL compatible pulse output to trigger devices like vibration data collectors or stroboscopes. The kit is supplied complete with a Remote Contact Assembly including concave and convex tips and a 10 cm linear speed wheel, all in a latching carrying case. Sensors, 12-inch Contact Wheel, and input/output cable are optional.

Specifications*	PLT200 Tachometer	
Display	5-digit, 5-digit alphanumeric LCD	
Range (Optical)	5 to 200,000 RPM (subject to ambient light intensity)	
Range (Contact)	0.5 to 20,000 RPM (also reads RPS and RPH)	
Rates	10 cm Contact Wheel	12 in. Contact Wheel
Inch/min	1.969 to 78,740	6.000 to 144,000
Feet/min	0.164 to 6,561.7	0.500 to 12,000
Yard/min	0.055 to 2,187.2	0.167 to 4,000
Cm/min	5.000 to 200,000	15.240 to 365,760
Meter/min	0.050 to 2,000.0	0.153 to 3,657.6
Totalizer	1-999,990 (events or length)	
Timer	99:59.9 (min., sec., tenths)	
Accuracy	Optical: $\pm 0.01\%$ of reading Contact: $\pm 0.05\%$ of reading	
Resolution	0.001 to 10 RPM (range dependent)	
Operating Distance	2" to 25' (5 cm to 7.62 m), $\pm 70^\circ$ from perpendicular	
Memory	Max, Min., and Last	
Power	2 AA 1.5 V dc batteries (30 hours)	
Environmental	5°C to 40°C (40°F to 105°F), 80% RH up to 31°C (88°F)	
Dimensions	6.92 x 2.4 x 1.6 in. [17.58 x 6.10 x 4.06 cm]	
Weight	7 ounces (210 grams)	

*Specifications are subject to change without notice.



View display and target

Features:

- Contact or non-contact modes
- View display and target simultaneously
- Lightweight
- Operates up to 25 feet from target
- Use remote sensors
- TTL input/output (3.5mm phone plug)

Ordering Information

Model	Description	Part No.
PLT200	Tachometer, batteries, 12 inches of T-5 tape, and NIST Certificate	6125-010
PLT200 Kit	Same as above with Remote Control Assembly with tips, 10 cm linear speed wheel, and standard latching carry case	6125-011

Accessories available on [website](#)

For details, see [PLT200 webpage](#).

Pocket Tach 99 (PT99 Tachometer)

The Pocket Tach 99 (PT99) is a digital, battery-powered portable non-contact optical tachometer, which operates up to 36 inches from a reflective target using a bright red LED light source. The ergonomic design allows safe, direct line-of-sight viewing of both the rotating target and the display at the same time, while providing a non-slip rubber surface for single-hand operation. The PT99 is the value leader of the world-class Pocket Tach Series from Monarch.

Specifications*	PT99 Tachometer
Display	5-digit, 5-digit alphanumeric LCD
Range	5 to 99,999 RPM
Accuracy	0.01% of reading or ± 1 digit
Resolution	Auto ranging: 0.001 to 1 RPM Fixed: 1 digit
Operating Distance/Range	2" to 36" [5 cm to 91.44 cm], $\pm 45^\circ$ from perpendicular
Memory	Max, Min., and Last
Power	2 AA 1.5 V dc batteries (60 hours)
Environmental	5°C to 40°C (40°F to 105°F), 80% RH up to 31°C (88°F)
Dimensions	6.92 x 2.4 x 1.6 in. [17.58 x 6.10 x 4.06 cm]
Weight	7 ounces (210 grams)

*Specifications are subject to change without notice.

Features:

- 36 in. operating distance
- One-handed operation
- LED light source
- Simple operation

Ordering Information

Model	Description	Part No.
PT99	Tachometer with 12 inches of T-5 tape, batteries	6109-010
PT99 with NIST	Same as above with NIST Certificate	6109-010-CAL

Accessories available on [website](#)

For details, see [PT99 webpage](#).



ACT Series Panel Tachometers/Totalizers



ACT-3X

The ACT Series Panel Tachometers consists of two models — one tachometer and one tachometer/rate meter/totalizer. Both feature inputs for two and three wire sensors providing signals of 0-5 V TTL or 0-1.1 V ac to 0-50 V ac. Both models operate with all Monarch sensors (see Pages 17-20) and display in fixed or floating decimal point format. The ACT-3X dual channel input provides the best feature set of any panel or benchtop instrument available today.

Features of the ACT-1B:

- 5-99,999 RPM
- Economically priced
- Output options: 4-20 mA, 0-5 V dc or TTL pulse

Features of the ACT-3X:

- 5-999,990 RPM
- NIST Traceable Calibration Certificate
- Standard TTL pulse repeater output
- Optional 4-20 mA, 0-5 V dc, and 2 alarm outputs
- Single event capture from start and stop pulses in units such as mph, cm/sec, etc. using two sensors for linear rate of travel on second input channel



Specifications*	ACT-1B	ACT-3X
Speed Range	5-99,999 RPM	5-999,999 RPM (speeds below 5 RPM possible with multiple pulses per revolution)
Accuracy	± 1 RPM or 0.005% of reading	± 0.001% of reading or ± 1 of displayed value (standard gate) ± 0.006% of reading or ± 1 of displayed value (fast gate)
Resolution	1 RPM	Up to 0.001 RPM, 10 RPM (100,000 to 999,990 RPM)
Totalizer/Counter	N/A	Display Range: 0.001 to 99,999
Alarm Capability	N/A	Two alarm set points: set as High or Low; latching or non-latching Hysteresis and low limit lockout are programmable
Alarm Output	N/A	Two Form C relay contacts rated 1 Amp at 230 V ac, can be set as failsafe
Communications	3.5 mm phone plug	Standard serial: 3.5 mm phone plug Optional: RS232C, USB type B or Ethernet
Scale Factor	N/A	0.0001-9999.9
Input Configuration	Universal inputs for all Monarch Sensors or TTL input or 1.5 to 50 V ac input	
Analog Output	Voltage: 0-5 V dc, 5 mA max load or Current: 4-20 mA, 500Ω max. 1-5 V dc with 250Ω resistor	
Pulse Repeater	0-5 V TTL compatible. One pulse out for each pulse in.	
Display	5 digits, 0.56" (14 mm) high red LED	
Display Update	2x per second above 120 RPM	
Input Power	Standard: 100-240 V ac, 50/60 Hz Optional: 12 or 24 V dc ± 20%, Isolated, 5 watts	
Sensor Power	5 V dc or 12 V dc or optional 24 V dc to sensor	
Dimensions	1/8 DIN by 4.5" (114 mm) deep	

*Specifications are subject to change without notice.

PM Remote Software



Free downloadable Windows®-based software application to further enhance the ACT Panel Tachometer's capabilities. Use your PC to customize the ACT's configuration or view real-time data over the communications interface.

- Set the mode of operation to RPM, RPS or Frequency
- Select the input scale (pulses per revolution)
- Real-time data can be displayed directly on the PC along with min and max values
- Decimal places and display update rate are user configurable
- And much more...

[See Monarch's website for full details.](#)

Ordering Information

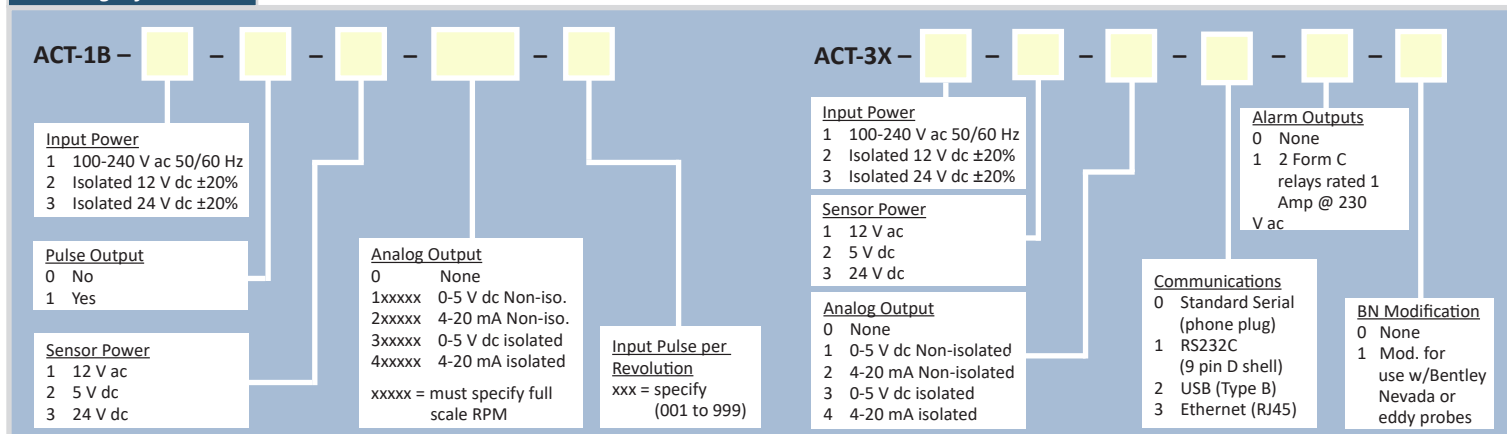

Accessories available on website

For details, see ACT webpages.

F2A1X Frequency to Analog Converter/Tachometer



The F2A1X Frequency to Analog Converter module converts a frequency input signal into a proportional analog voltage (0-5 V dc) or current (4-20 mA) output. The output signal is electrically isolated from input signal and input power source effectively eliminating troublesome ground loops. The input signal can be supplied from a Monarch sensor (measuring RPM for example) or any source of digital signal not exceeding 12 volts. The F2A1X is factory preprogrammed with the full scale output and input scale factor of your choice. These settings are also user configurable with the optional USB programming cable and [free downloadable PM Remote Software](#). PM Remote Software also displays data in real-time. The F2A1X requires 12-24 V dc input power.



Features:

- Economically priced
 - Rugged, compact and lightweight
 - Electrically isolated input/output
 - 5 to 600,000 RPM range (0.1 to 10kHz)
 - Compatible with most speed sensors (TTL)
 - 12 to 24 V dc input power
 - User configurable[†]
 - View real-time data on PC[†]
 - 4-20 mA or 0-5 V dc scalable output
 - 5 V dc or 10 V dc sensor supply (jumper selectable)
- [†]Requires optional USB programming cable and free downloadable PM Remote Software

Specifications*	F2A1X Frequency to Analog Converter/Tachometer
Input Range	0.1 to 10,000 RPM (5 to 600,000Hz)
Accuracy	0.005%
Resolution	76 μ volts or 30.5 nanoamps
Power Supply	12 to 24 V dc \pm 5% @ 150 mA max
Inputs	TTL input or \pm 3V ac to \pm 12 V ac, scaling is programmable using PM Remote Software and USB programming cable
Sensor Excitation	5 V dc or 10 V dc @ 75 mA (user selectable jumper setting)
Current Output Option	4-20 mA out, 16 bit resolution. Zero and full scale setting as specified when ordered or programmable using PM Remote Software and USB programming cable
Voltage Output Option	0-5 V dc out, 5 mA 16 bit resolution. Zero and full scale setting as specified when ordered or programmable using PM Remote Software and USB programming cable
Dimensions (LxHxW)	80 x 40 x 28 mm (3.2 x 1.6 x 1.2") excluding mounting wings
Environmental	Indoor use only, installation category II per IEC 664 Temperature: -10° to 50 °C operating per IEC 61010-1 Humidity: 80% max for temps up to 31 °C, decreasing linearly to 50% RH at 40 °C

*Specifications are subject to change without notice.

Ordering Information

Configure Model # here: **F2A1X** - [] - [] - []

Input Mode (select input measurement mode)

- 1 Frequency (Hz/RPS)
- 2 RPM (assumes 1 pulse per revolution)
- 3 Custom (contact factory or order optional PM Remote Software and USB programming cable)

Analog Output

- 1 0 to 5 V dc, Isolated
- 2 4-20 mA, Isolated

Full Scale Output

xxx Specify full scale output of analog signal (1 to 600,000)

Application Example 1: Convert 0 - 5000 RPM signal to a 4-20 mA output
Model number = F2A1X-2-2-5000

Application Example 2: Convert a 0 to 8kHz signal to a 0-5 V dc output that is proportional to 0 - 200,000 GPH (Gallons Per Hr)
Model number = F2A1X-1-1-200,000

Accessories available on website

For details, see [F2A1X webpage](#).

PM Remote Software



Free downloadable Windows®-based PM Remote Software allows users to quickly and easily customize the configuration of Monarch's F2A1X, and Panel Tachometers.

- Set the mode of operation to RPM, RPS or Frequency
- Select the input scale (pulses per revolution)
- Real-time data can be displayed directly on the PC along with min and max values
- Decimal places and display update rate are user configurable
- And much more...

[See Monarch's website for full details.](#)

Recommended Sensors (see pages 17 - 19):

- Optical — ROS-W
- Laser — ROLS-W
- Rugged — RLS-W
- Infrared — IRS-W

F2A3X Frequency to Analog Converter/Tachometer



The F2A3X Frequency to Analog Converter/Tachometer is a DIN rail module that converts a frequency input signal into a proportional analog voltage (0-5 V dc) or current (4-20 mA) output. The output signal is electrically isolated from input signal and input power source effectively eliminating troublesome ground loops. The input signal can be supplied from a Monarch sensor (measuring RPM for example) or any source of digital signal not exceeding 12 volts. The F2A3X is completely user programmable using the [free downloadable PM Remote Software](#).

Features:

- Standard DIN rail mounting
- Ethernet communications available
- 5 to 999,990 RPM range (0.083 to 250kHz)
- Compatible with most speed sensors (TTL)
- 12 to 24 V dc input power
- Alarm set-point with optional relay output
- Pulse repeater output
- User configurable
- View real-time data on PC
- 4-20 mA or 0-5 V dc scalable output
- 10 V dc or 5 V dc sensor excitation

Specifications*	F2A3X Frequency to Analog Converter/Tachometer
Input Range	5-999,990 RPM speeds below 5 RPM possible with multiple pulses per revolution (0.083Hz to 250kHz)
Input Configuration and Voltage Range	1 to 9,999 pulses per revolution or use a scale factor of 0.0001 to 99,999—PC software programmable, TTL input and 1.1 V to 25 V dc signals—Internal Jumper for ± 1 to ± 25 V ac
Analog Output	Voltage: 0-5 V dc, 5 mA max load, Isolated or 4-20 mA Isolated, 500Ω max load, Internal 12 V compliance voltage, 16 bit resolution. Full scale and offset RPM ranges PC programmable
Accuracy/Resolution	0.005% of full scale output / 76 μvolts or 30.5 nanoamps
Output Update	Software selectable up to 244 times/sec-dependent on input frequency
Memory	Maximum and minimum recall via PC software
Input Power	Standard 12-24 V dc 4.5W max or optional 12 V dc to 24 V dc isolated 4.5W max
Sensor Excitation	10 V dc @ 60 mA standard or optional 5 V dc @ 60 mA
Pulse Repeater Output	0-5 V TTL compatible, one pulse out for each pulse in. Polarity is software selectable
Communications	Ethernet RJ45 or USB type B
Alarm Capability	Optional alarm with relay output Set-points: high or low alarm limit, latching or non-latching PC programmable
Alarm Outputs	1 Form C relay contact, rated 1A at 115 V ac or 230 V ac
Alarm Reset	Automatic or manual reset; front panel push-button or remote reset via PM Remote Software
Dimensions	1/8 DIN by 3.94" (100 mm) deep
Environmental	Indoor use only, installation category II per IEC 664 Temperature: -10° to 50 °C operating per IEC 61010-1 Humidity: 80% max for temps up to 31 °C, decreasing linearly to 50% RH at 40 °C

*Specifications are subject to change without notice.

Ordering Information

Configure Model # here:

F2A3X — [] — [] — [] — [] — [] — []

Input Power

- 1 12-24 V dc Non-isolated
- 2 12-24 V dc isolated

Sensor Power

- 1 10-12 V dc
- 2 5 V dc

Analog Output

- 1 0-5 V dc isolated
- 2 4-20 mA isolated

Communications

- 1 USB Type B
- 2 Ethernet (RJ45)

Alarm Output

- 0 None
- 2 1 Form C Relay

Bentley Nevada Mod

- 0 None
- 1 Modification to support use of Bentley Nevada or eddy style probes

Accessories available on website

For details, see F2A3X webpage.

PM Remote Software



Free downloadable Windows®-based software application that allows users to quickly and easily customize the configuration of Monarch's F2A3X Frequency to Analog Converter/Tachometer.

- Set the mode of operation to RPM, RPS or Frequency
- Select the input scale (pulses per revolution)
- Real-time data can be displayed directly on the PC along with min and max values
- Decimal places and display update rate are user configurable
- And much more...

[See Monarch's website for full details.](#)

Recommended Sensors (see pages 17-19):

- Optical — ROS-W
- Laser — ROLS-W
- Rugged — RLS-W
- High-Temp — ROS-HT-W-25
- Modulated — ROSM-5W
- Magnetic — MT-190W
- Infrared — IRS-W

ROS Remote Optical Sensor

ROS (Remote Optical Sensor): Threaded stainless steel remote optical sensors have a visible red LED light source and green LED 'On Target' indicator. Performs over a wide speed range and operating envelope.

Common Usage: Wide range of general purpose applications in relatively clean environments

Specifications*	ROS Sensor
Operating Distance	3 ft. (1 m) and 45° from reflective tape
Speed Range	1-250,000 RPM
Operating Temp	14° to 158 °F (-10° to 70 °C)
Power Required	3.0 to 15 V dc @ 40 mA
Output Signal	TTL same as source
Standard Cable	8 ft. (2.4 m) or 25 ft. (7.6 m)
Dimensions (L x dia)	2.9 in. x 0.625 in. (74 x 16 mm)

*Specifications are subject to change without notice.

Ordering Information

Model	Description	Part No.
ROS-W	Sensor with 8 ft. cable with tinned leads, mounting bracket and 12" of T-5 tape	6180-056
ROS-P	Sensor with 8 ft. cable, 1/8" phone plug, mounting bracket and 12" of T-5 tape	6180-057
ROS-P-25	Sensor with 25 ft. cable, 1/8" phone plug, mounting bracket and 12" of T-5 tape	6180-057-25

[Accessories available on website](#)

[For details, see ROS webpage.](#)

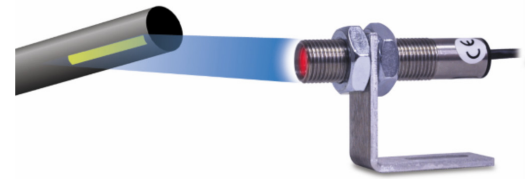

ROS-HT Remote Optical Sensor - High Temp

ROS-HT (Remote Optical Sensor, High Temp): Threaded stainless steel remote optical sensor with visible incandescent white light source. Ideal for automotive and truck cooling system testing or other applications with temperature ranges up to 257 °F (125 °C).

Common Usage: Automotive and heavy truck cooling fan speeds

Specifications*	ROS-HT Sensor
Operating Distance	2 ft. (61 cm) and 45° offset reflective tape
Speed Range	1-50,000 RPM
Operating Temp	-13° to 257 °F (-25° to 125 °C)
Power Required	6-24 V dc @ 48 mA
Output Signal	TTL same as source
Standard Cable	25 ft. (7.6 m)
Dimensions (L x dia)	2.9 in. x 0.625 in. (74 x 16 mm)

*Specifications are subject to change without notice.

Ordering Information

Model	Description	Part No.
ROS-HT-W-25	Sensor with 25 ft. cable with tinned leads, mounting bracket and 12" of T-5 tape	6180-058-25

[Accessories available on website](#)

[For details, see ROS-HT webpage.](#)

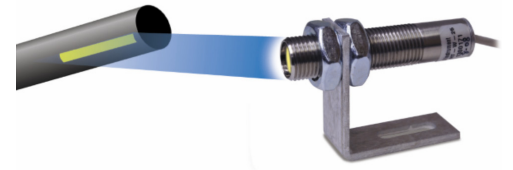

ROLS Remote Optical Laser Sensor

ROLS (Remote Optical Laser Sensor): Threaded stainless steel remote optical laser sensors have a visible red laser light source and green LED 'On Target' indicator. Performs over a wide speed range and operating envelope.

Common Usage: Wide range of applications where distance to target is large

Specifications*	ROLS Sensor
Operating Distance	Up to 25 ft. (7.62 m) and 70° offset from target
Speed Range	1-250,000 RPM
Operating Temp	14° to 158 °F (-10° to 70 °C)
Power Required	3.3 to 15 V dc, 35 mA or 24 V dc ± 10%
Output Signal	TTL same as source
Standard Cable	8 ft. (2.4 m) or 25 ft. (7.6 m)
Dimensions (L x dia)	3.12 x 0.71 in. (18 x 79.4 mm)

*Specifications are subject to change without notice.

Ordering Information

Model	Description	Part No.
ROLS-W	Sensor w/8 ft. cable with tinned leads, mounting bracket and 12" of T-5 tape	6180-030
ROLS24-W	Same as above with 24 V dc input power	6180-035
ROLS24-W-25	Same as above with 25 ft. cable with tinned leads	6180-035-25
ROLS-P	Sensor w/8 ft. cable, 1/8" phone plug, mounting bracket and 12" of T-5 tape	6180-029
ROLS-P-25	Same as ROLS-P, with 25 ft. cable	6180-029-25

[Accessories available on website](#)

[For details, see ROLS webpage.](#)

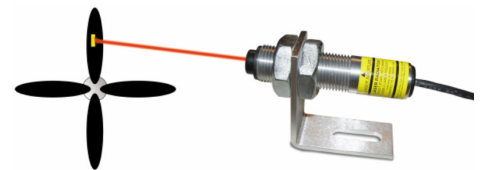

RLS Rugged Laser Sensor

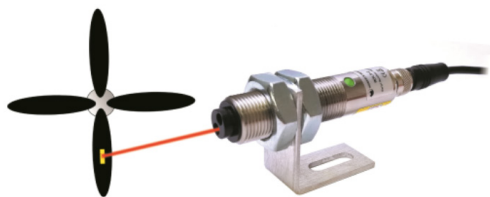

RLS (Rugged Laser Sensor): Threaded 316L stainless steel remote optical laser sensor with a visible red laser light source and green LED 'On Target' indicator. Performs over a wide speed range and operating envelope. The Rugged Laser Sensor is IP67 rated and includes a removable cable with water tight M12 connector for easy removal and cleaning.

Common Usage: Wide range of applications where distance to target is large or accidental exposure to water, oil, dust and other contaminants is possible

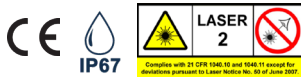

Ordering Information

Model	Description	Part No.
RLS-P	Sensor with mounting bracket, 3 m M12 cable to 1/8" phone plug cable, 12" T-5 tape	6180-081
RLS-W	Sensor with mounting bracket, 3 m M12 cable to tinned leads cable, 12" T-5 tape	6180-080
RLS24-P	24 V dc-powered sensor with mounting bracket, 3 m M12 cable to 1/8" phone plug cable, 12" T-5 tape	6180-083
RLS24-W	24 V dc-powered sensor with mounting bracket, 3 m M12 cable to tinned lead cable, 12" T-5 tape	6180-082

[Accessories available on website](#)

[For details, see RLS webpage.](#)

Specifications*	RLS Sensor
Operating Distance	Up to 25 ft. (7.62 m) and 60° offset from target
Speed Range	1-250,000 RPM
Operating Temp	14 °F to 122 °F (-10 °C to +50 °C)
Power Required	4 – 15 V dc ± 20% 0.5W or 10 – 24 V dc ± 20% 0.5W
Output Signal	TTL same as source
Standard Cable	10 ft. (3 m)
Dimensions (L x dia)	4.00 x 0.787 in. (101.7 x 20 mm)

*Specifications are subject to change without notice.

IRS Infrared Sensor



IRS (Infrared Sensor): Ideal sensor for working up to 0.5" (12 mm) from high speed equipment or other applications providing only contrasting light and dark surfaces or beam interruption by solid objects as small as 0.03" (1 mm).

Common Usage: Dentist and other high speed drills, slots or gear teeth. Does not require reflective tape. Use black/white contrasting colors.



Ordering Information

Model	Description	Part No.
IRS-P	Sensor with 8 ft. cable with 1/8" phone plug connector and mounting bracket	6180-020
IRS-W	Sensor with 8 ft. cable with tinned leads and mounting bracket	6180-021

[Accessories available on website](#)

[For details, see IRS webpage.](#)

Specifications*	IRS Sensor
Operating Distance	0.5 in. (12 mm)
Speed Range	1-999,990 RPM
Operating Temp	-40° to 185 °F (-40° to 85 °C)
Power Required	3.3 to 15 V dc, 40 mA
Output Signal	TTL same as source
Standard Cable	8 ft. (2.4 m)
Dimensions (L x dia)	2.9 x 0.625 in. (74 x 16 mm)

*Specifications are subject to change without notice.

GE200 HP Inductive Gasoline Engine Sensor

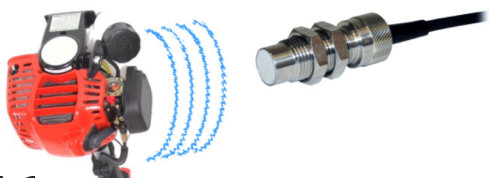

GE200 HP: Ideal sensor for detecting gasoline engine RPM. Up to 12 inches (304 mm) working distance from ignition coil or magneto. The GE200 HP must be connected to a Monarch amplifier module which provides input power and a TTL pulse output.

Common Usage: 2-cycle and 4-cycle gasoline/petrol engines



Ordering Information

Model	Description	Part No.
GE200 HP	Electromagnetic inductive spark plug sensor with 15 ft. cable <i>Amplifier module required for proper operation.</i>	6180-014
Mag Amp	Amplifier for GE200 HP Sensor. 3 ft. cable with 1/8" phone plug	4180-405
Mag Amp	Amplifier for GE200 HP Sensor. 3 ft. cable with tinned leads	4180-406

[Accessories available on website](#)

[For details, see GE200 HP webpage.](#)

Specifications*	GE200 HP Sensor
Operating Distance	Up to 12 inches (304 mm)
Speed Range	1-99,999 RPM
Operating Temp	-65° to 225 °F (-54° to 107 °C)
Power Required	3.3 to 24 V dc, 4mA
Output Signal	TTL same as source
Standard Cable	15 ft. (4.5 m)
Dimensions (L x dia)	2.01 x 0.55 in. (51 x 13.9 mm)

*Specifications are subject to change without notice.

M-190 and MT-190 Magnetic Sensors/Amplifiers

M-190 (Magnetic Sensor): Most popular sensor for measuring speed using gear teeth. Sensor mounts within 0.005 inches (0.127 mm) of a minimum 0.1 inch (2.5 mm) target. Requires no power from the display module and self-generates an AC signal.

MT-190 (Magnetic Sensor with Amplifier): Extends operating gap to 0.25 inches (6.35 mm) from the target. Frequently used on gears as the M-190, but can also sense bolt heads or shaft keys and provides a TTL output signal that is equal to the source voltage.



Common Usage: Ferrous metal targets including gear teeth bolt heads or online systems' shaft keys

Specifications*	M-190	MT-190
Operating Distance	0.005" (0.127 mm) gap w/ 0.1" target (2.5 mm) min.	0.25" (6.35 mm) gap with 0.1" target (2.5 mm) min.
Speed Range	1-99,999 RPM	
Operating Temp	-100° to 250 °F (-73° to 120 °C)	20° to 160 °F (-6° to 70 °C)
Power Required	None (self-generating)	3.3 to 24 V dc, 15 mA
Output Signal	190 V peak to peak	TTL same as source
Standard Cable	10 ft. (3 m)	Sensor: 10 ft. (3 m) Amplifier: 1.5 ft. (0.46 m)
Dimensions (L x dia)	2 in. x 0.625 in. (51 x 16 mm)	Amplifier: 2.65" (L) x 1.38" x 1.05" (67.3 x 35.0 x 26.7 mm)

*Specifications are subject to change without notice.

Ordering Information

Model	Description	Part No.
M-190W	Sensor w/ 10 ft. cable w/ tinned leads	6180-012
MT-190W	Sensor w/ 10 ft. cable w/ tinned leads; amplifier with tinned leads	6180-037
MT-190P	Sensor w/ 10 ft. cable w/ tinned leads, amplifier w/ phone plug connector	6180-036

For details, see [Magnetic Sensors webpage](#).

P5-11 Proximity Sensor

P5-11: A two-wire probe style inductive sensor for use up to 0.2 inches (5 mm) from 0.5 inch (12 mm) metallic target such as bolt head or shaft locking key.

Common Usage: Permanent installation in harsh industrial environments

Specifications*	P5-11 Sensor
Operating Distance	0.2 in . (5 mm) from 0.5 in. (12 mm) metal target
Speed Range	1-60,000 RPM
Operating Temp	-13° to 158 °F (-25° to 70 °C)
Power Required	5-30 V dc, 3mA
Output Signal	NAMUR (DIN 19234)
Standard Cable	10 ft. (3 m)
Dimensions (L x dia)	1.33 in. x 0.55 in. (34 x 14 mm)

*Specifications are subject to change without notice.

Ordering Information

Model	Description	Part No.
P5-11	Proximity sensor with 10 ft. cable	6180-013

For details, see [P5-11 webpage](#).

PS-12 Proximity Sensor

PS-12: A three-wire threaded IP67 metal sensor that outputs an open collector PNP pulse. Operates at a 0.15 inch (4 mm) gap with a 0.5 inch (12 mm) target. Includes red LED on target indicator.

Common Usages: Permanent installation in harsh industrial environments and online vibration data collectors

Specifications*	PS-12 Sensor
Operating Distance	0.15 in . (4 mm) from 0.5 in. (12 mm) metal target
Speed Range	1-24,000 RPM
Operating Temp	-13° to 167 °F (-25° to 75 °C)
Power Required	6 to 36V dc, 15 mA
Output Signal	PNP Open Collector
Standard Cable	6 ft. (1.8 m)
Dimensions (L x dia)	2.1 in. x 0.47 in. (54 x 12 mm)

*Specifications are subject to change without notice.

Ordering Information

Model	Description	Part No.
PS-12	Proximity sensor with 6 ft. cable	6180-032

For details, see [PS-12 webpage](#).

SPSR Self-Powered Sensor



The unique Self-Powered Sensor (SPSR) provides a square wave pulse output from any of five input sensors: RLS-P, ROLS-P, ROS-P, IRS-P or MT-190P (See pages 17-19 for details). The TTL compatible pulse output is switch selectable as either positive going 0-5 V pulses or negative going 5-0 V pulses provided on a BNC connector. Internal rechargeable batteries provide 40 hours of operation between charges. For continuous operation, the SPSR can be powered by the included 115/230 V ac universal recharger/power supply with interchangeable wall plugs. Self-powered sensors are a critical element for providing one TTL pulse per revolution for vibration analyzers, spectrum analyzers, stroboscopes, data acquisition equipment, tachometers, balancers, and waveform analyzers.



Ordering Information

Model	Description	Part No.
SPSR-115/230	SPSR interface module, power supply/recharger, ROS-P and 12" of T-5 tape	6150-020
SPSR-IM	SPSR interface module only, with power supply/recharger	6150-021

Accessories available on website

For details, see SPSR webpage.

Specifications*	SPSR Sensor
Range (RPM)	Same as sensor
Output Signal	TTL 0-5 V or 5-0 V (user-selectable polarity)
Pulse Width	Determined by target size and rotational speed
Output Connector	BNC connector
Power	Rechargeable NiMH batteries, 40 hours or continuous with 115/230 V ac supply/recharger with interchangeable wall plugs

*Specifications are subject to change without notice.

CSLS Compact Smart Laser Sensor



The Compact Smart Laser Sensor (CSLS) is a self-contained optical sensor intended to be used to make non-contact speed measurements from rotating targets at distances up to 65 feet (19.8 m). The sensor has both digital pulse and analog outputs to provide non-contact reference points to balancing equipment or signals to a vibration analyzer. The sensor will track surface irregularities on rotating shafts and provide pulse outputs from reflective tape, contrasting colors and keyways. The sensor is IP64 rated and is suitable for use in dusty damp environments. Includes ¼-20 tripod mounting bushing.

Features:

- TTL 0-3.0 V pulse output
- Analog output to provide reference points for balancing or vibration analyzers
- Measure rotating targets up to 65 feet away



Ordering Information

Model	Description	Part No.
CSLS	CSLS with 3 m power/output cable and roll of T-5 tape	6180-038

Accessories available on website

For details, see CSLS webpage.

Specifications*	CSLS Sensor
Optical	Class 3R (per IEC 60825-1) visible laser 650nm @ 3 mW peak power
Operating Range	Up to 65 ft. (19.8 m) from T-5 reflective tape
Speed Range	1-500,000 RPM
Output Signal	TTL 0-3.0 V typical (positive going pulse)
Operating Temp	32° to 120 °F (0° to 50 °C)
Dimensions	3.5 x 2.4 x 2.2 in. (89 x 60 x 55 mm)
Power	5 V dc ± 5% @ 30 mA max

*Specifications are subject to change without notice.

SLS Smart Laser Sensor



The Smart Laser Sensor (SLS) is an internal battery-powered optical speed sensor utilizing a visible Class 3R Laser for a TTL pulse output. Operating range up to 65 feet (19.8 m) with reflective tape and up to 3 feet (1 m) from contrasting color targets, keyways, bolt heads or blades.

Features:

- "Smart" auto gain provides best performance in picking up target reflections
- Manual sensitivity knob provides dynamic fine tuning of sensor response
- Signal/Pulse/RS232 Output DIN connector port
- TTL pulse output signal inverter switch
- External DC power/recharger port for continuous operation (24/7)



Ordering Information

Model	Description	Part No.
SLS 115/230	SLS with 115/230 V ac universal power supply/recharger, BNC cable, 12" of T-5 tape, and NIST Certificate	6180-022

Accessories available on website

For details, see SLS webpage.

Specifications*	SLS Sensor
Optical	Class 3R (per IEC 60825-1) visible laser 650nm @ 3 mW peak power
Operating Range	Up to 65 ft. (19.8 m) from T-5 reflective tape
Speed Range	1-500,000 RPM
Output Signal	TTL 0-5 or 5-0 V user-selectable polarity, R232
Operating Temp	32° to 104 °F (0° to 40 °C)
Dimensions	5.38 x 2.53 x 2.25 in. (136 x 64 x 57 mm)
Power	Internal 4 AA rechargeable NiCd 700 mAh batteries

*Specifications are subject to change without notice.

DataChart™ DC1250 Dual-Channel Recording Tachometer

The DataChart™ DC1250 is a feature-rich data acquisition system offering 2 universally configurable inputs for measuring DC voltage, DC current, thermocouples and RTDs as well as frequency and pulse inputs. 4 internal alarm set-points, 2 alarm relay outputs and 1 digital control input are all standard. A maximum sample storage rate of 100 samples per second can be set for both channels allowing for capture of short duration process signal anomalies. CompactFlash™ cards up to 2 gigabytes in size can be used allowing many data points to be stored over long periods of time.

The unit is compatible with many of Monarch's speed measurement sensors. Power for sensors is provided from the DC1250 rear terminals. Measure, display and record RPM ranges from 5 to 600,000. Choose the sensor best suited for your application or take your existing signal directly into the DC1250.



Recommended Sensors (see pages 17 - 19)

- Optical — ROS-W
- Laser — ROLS-W
- Rugged — RLS-W
- Infrared — IRS-W
- Magnetic — MT-190W

Specifications* (abbreviated)	DataChart 1250 Dual-Channel Recording Tachometer
Input Power:	
Standard	9V dc ±0.5 V dc @ 5 VA (depends on external loads) provided by external AC wall transformer, non-isolated. 100-240 V ac 50/60 Hz
Option	Isolated 12-24 V dc input power available (not compatible with internal battery pack option below)
Battery Option	Internal battery pack provides uninterrupted operation and controlled shutdown during blackout. 6V dc, 2400 mA NiMH
No. of Channels	2 universal, user selectable
Isolation	300 V AC/DC channel input to chassis ground
Input Types	
DC Voltage:	
Ranges	0-250mV; 0-1.25 V; 0-2.5 V; 0-5 V; 0-12.5 V; 0-25 V
Accuracy	0.1% of reading
Resolution	0.025% of full scale
DC Current:	
Ranges	0-20 mA; 4-20 mA; 0-50 mA; 10-50 mA
Accuracy	0.1% of reading excluding 250 ohm external shunt (required)
Resolution	0.025% of full scale
Frequency Input:	
Range	0-10,000Hz / 0 - 600,000 RPM
Accuracy	Freq: ± 1Hz; RPM: ± 1 RPM below 9,999, ± 10 RPM above 9,999 RPM
Input	Low < 1.0 V dc; High > 3.0 < 12.0 V dc
Pulse Width	10 microsecond minimum
Input Impedance	> 100K ohms
Measure Rate	Up to 100 samples/second per channel
Math Functions	Y = mx + b, average, hi peak, low peak, and totalization
Media	CompactFlash™ up to 2GB size max
Display	LCD graphics, 160 x 80 pixels, black FSTN with white LED backlight; User-controlled backlight level and contrast adjust
User Interface	5-button keypad (dual function buttons)
Clock	Auto leap year and daylight savings adjustment. Internal battery back-up
Relay Outputs	Two alarm outputs: 30 V 0.5A Form A relays
Voltage Output	2 outputs 5 V dc @ 50 mA to power external sensors
Control Input	One input, 5 to 12 V dc activation @ 10 mA typical
Audible	Internal beeper (multiple tones)
Dimensions	Front panel: 3.78 x 3.78 x 6 in. (96 x 96 x (1/4 DIN) x 152 mm)

*Specifications are subject to change without notice.

Temperature Inputs		
Thermocouple:	Range °F	Range °C
J	-148 to 1400 °F ±3°	-100 to 760 °C ±2°
K1	-148 to 1832 °F ±3°	-100 to 1000 °C ±2°
K2	32 to 2498 °F ±3°	0 to 1370 °C ±2°
T	-148 to 750 °F ±3°	-100 to 400 °C ±2°
E	-112 to 750 °F ±3°	-80 to 400 °C ±2°
Accuracy: 0.3% of full scale (typical); Ambient temperature sensor accuracy ±1.5 °C		
RTD (2 or 3 wire):	Range °F	Range °C
100 ohm Pt 385	-148 to 1380 °F	-100 to 750 °C
100 ohm Pt 392	-148 to 1380 °F	-100 to 750 °C
Accuracy: 0.3% of full scale (typical) Resolution 0.1 °C Internal current source: 1mA		

Ordering Information

Configure Model # here:

DC1250 — [] — [] — []

3) Choose Communications:

- 0 None
- 1 USB
Mini-USB port for downloading data directly to PC; front access
- 2 Ethernet
10/100 BaseT rear access RJ45 connector; allows network access to recorder

1) Choose Input Power:

- U AC Adapter 100-240 V ac wall adapter with interchangeable plug set
- D 12-24 V dc isolated input power

2) Choose Backup:

- 0 None
- 1 Battery Backup* Rechargeable NiMH battery pack will power recorder up to 6 hours if power loss

*Not available with Option "D" DC Input Power

Accessories available on website

www.monarchinstrument.com // sales@monarchinstrument.com // 800-999-3390

For details, see DC1250 webpages.

Portable USB Temperature/Humidity Probe/Data Logger



The Portable USB Temperature and Humidity Probe combines high accuracy temperature and humidity sensors into a rugged stainless steel probe with built in USB interface. The probe can be used with Windows-based PCs or Android devices that support On-The-Go communications. To use with an Android device simply download the free App from Google Play, plug the probe into your device with the supplied interface cables and start the application. The probe receives its power from the host USB device. Real-time data is displayed and can be stored for review on the PC using a spreadsheet or review data graphically using our free Track-It™ Data Logger Software. Available in 12" or 18" (300 mm or 450 mm) lengths. The probe comes standard with a free flow Delrin cap. Optional sintered stainless steel filter caps are available for measuring dry bulk material or for use in dusty/dirty environments.

Features:

- Rugged stainless steel construction
- 6.5' (2 meter) USB cable included
- Android On-The-Go cable included
- High accuracy and repeatability
- Dew point calculation

Typical uses:

- HV ac spot checking
- Dry bulk material measurement
- Environmental chambers
- Laboratories
- Storage facilities

Android device not included.

Android is a trademark of Google LLC

App and Software

The Portable USB Temperature Humidity Probe includes a suite of free software products that enhance your ability to measure, record, analyze, trend and print historic data. Begin by installing and using either the Humidity/Temperature Probe Android App or the TH Probe PC Software. View and record real time digital temperature, humidity and dew point data and then use our free Track-It Data Logger Software to view historic data in graphic format.



Scan code or Download free Android App here:

<https://play.google.com/store/apps/details?id=com.trackit.thProbe&hl=en>

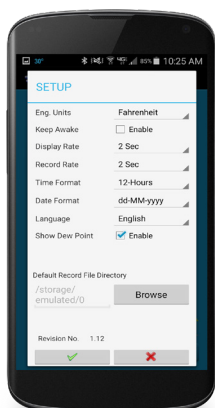
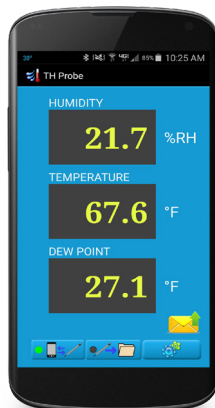

Android App

THProbe PC Software

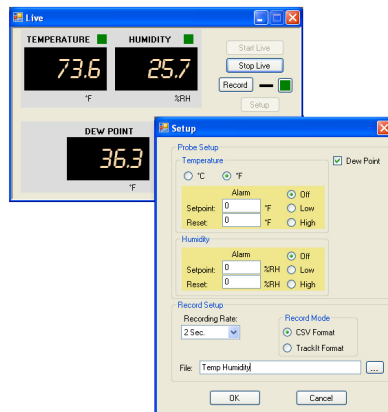

Download the free PC Software:

<https://monarchinstrument.com/products/th-probe-software>

Track-It Software



Download Track-It Software:

https://monarchinstrument.com/Software/Track-It_Software.zip

Ordering Information

Model	Description	Part No.
12" USB T/H Probe	Probe with 2 m USB interface cable and Android On-The-Go cable	6184-010
12" USB T/H Probe NIST	Same as above with NIST Certificate	6180-010-CAL
18" USB T/H Probe	Probe with grip, 2 m USB interface cable and Android On-The-Go cable	6184-011
18" USB T/H Probe NIST	Same as above with NIST Certificate	6184-011-CAL
Filter Cap	Sintered filter cap 30-45 microns	6184-901
Filter Cap	Sintered filter cap 60-90 microns	6184-902

Accessories available on website

For details, see TH-Probe webpage.

Specifications*	Conditions	
Temperature		
Max Range	Probe tip only	-40 to 257 °F (-40 to 125 °C)
Recommended Operating Range		32 to 185 °F (0 to 85 °C)
Accuracy	32 to 212	±0.4 °F
	0 to 100	±0.2 °C
Relative Humidity		
Range		0-100 %RH
Accuracy (@25 °C)	10 to 90	±1.2 %RH
Repeatability		±0.1 %RH
Response	Tau at 63% [§]	10 sec

*Specifications are subject to change without notice.

†Range applies to sensor end of probe only

§With standard slotted cap

For fully detailed accuracy plots, see product's User Manual.

Examiner 1000 Vibration Meter



The Examiner 1000 overall vibration meter and electronic stethoscope is the ideal tool for cost effective predictive maintenance. This meter is simple to operate with only one button and volume adjustment. Troubleshoot bearings and lubrication with the digital LCD and stethoscope features to enhance machinery reliability. Compare your vibration results by using the ISO 10816 Severity Chart right on the meter. NIST traceable calibration is available.



Features:

- Electronic stethoscope - troubleshoot while listening to the bearing
- Measure vibration in:
 - Acceleration - perfect for high-speed applications
 - Velocity - in English or Metric per ISO 10816
 - Acceleration Envelope - high pass filter method

Facilities that establish a predictive maintenance program are able to:

- Improve machinery reliability and reduce unplanned failures
- Reduce maintenance costs
- Optimize machinery performance to increase productivity
- Lower energy consumption - less vibration usually means less friction
- Extend bearing service life

Why Measure Vibration?

Vibration is considered the best operating parameter to judge dynamic conditions such as balance (overall vibration), bearing defects (enveloping) and stress applied to components. Many machinery problems show themselves as excessive vibration. Rotor imbalance, misalignment, mechanical looseness, structural resonance, soft foundation, and gear mesh defects are some of the defects that can be measured by vibration. Measuring the “overall” vibration of a machine, a rotor in relation to a machine or the structure of a machine, and comparing the measurement to its normal value (norm) indicates the current health of the machine.

Specifications*	Examiner 100
Amplitude Ranges:	
Acceleration	0.01 to 19.99 g (RMS)
Velocity	0.01 to 19.99 in./sec (RMS) 0.1 to 199.99 mm/sec (RMS)
Envelope	0.01 to 19.99 ge (PEAK)
Frequency Ranges	Overall: 10Hz to 10kHz Envelope: 0.5kHz to 10kHz
Display Indications	LCD 3.5-digit (with Measurement, Hold and Low Battery)
Vibration Sensor	Piezoelectric accelerometer 100 mV/g
Output	Audio: 3.5 mm mini plug Sensor power: 18V dc @ 2 mA (BNC)
Power	2 AA cell batteries
Operating Time	20 hours continuous without headphones
Operating Temperature	-14 to 122 °F (-10 to 50 °C)
Dimensions	6.3 x 3.3 x 1.25 in. (1.60 x 84 x 32 mm)
Weight (full kit)	2.85 lbs. (1.30 kg)

*Specifications are subject to change without notice.

Vibration Severity Per ISO 10816-1

	Machine		Class I Small Machines	Class II Medium Machines	Class III Large Rigid Foundation	Class IV Large Soft Foundation
	In/s	mm/s				
Vibration Velocity Vrms	0.01	0.28				
	0.02	0.45				
	0.03	0.71		Good		
	0.04	1.12				
	0.07	1.80				
	0.11	2.80		Satisfactory		
	0.18	4.50				
	0.28	7.10		Unsatisfactory		
	0.44	11.2				
	0.71	18.0				
1.10	28.0		Unacceptable			
1.77	45.0					

Ordering Information

Model	Description	Part No.
Examiner 1000 Kit	Complete vibration meter and electronic stethoscope kit. Includes: Vibration meter, batteries, accelerometer and integrated cable, magnetic base, stinger probe, stereo headphones, field carrying case, and machinery data worksheet	6400-011
Examiner 1000 Kit with NIST	Same as above with NIST Calibration Certificate	6400-011-CAL

[Accessories available on website](#)

[For details, see Examiner webpage.](#)

The Professional's Choice for over 40 years!

Founded in 1977, Monarch Instrument started by distributing a diverse range of instrumentation and then transitioned to manufacturing products in the USA becoming known as the premier supplier of rotational speed measuring instruments and stroboscopic inspection equipment. Our comprehensive lines of precision products and calibration services make Monarch the professional's choice for tachometers, stroboscopes, speed sensors, data loggers, and data acquisition systems.

Monarch's multi-patented and trademarked technologies are precise, rugged and reliable:

- illumiNova® Fixed Mount Stroboscopes
- Nova-Pro® Stroboscope/Tachometers
- Nova-Strobe™ LED and Xenon Stroboscopes
- Palm Strobe x LED Stroboscope
- Track-It™ Data Loggers
- DataChart™ Paperless Recorders

Monarch's full-service sales force and worldwide distribution network stand ready to answer purchase and product application questions. Please feel free to contact us directly or visit our website to locate a distributor in your area. We take pride in our products and services and offer unsurpassed customer service. Monarch Instrument is an ISO 9001:2015 certified facility.

Monarch Instrument is committed to excellence and quality in manufacturing, sales, and service.



Portable Tachometers



Panel Tachometers



Frequency Converters



Track-It™ Data Loggers



Fixed Mounted Strobes



Portable Strobes



Speed Sensors



DataChart™ Paperless Recorders



Proudly distributed by:

Follow us!

